

Data Sheet



Article number: 310101022002200

Description: Vibrator motor SPX - 50 1.8 A 4.4kgcm
3000 o/m 220kg 0,19kW 3x230-400V 50hz

Measures

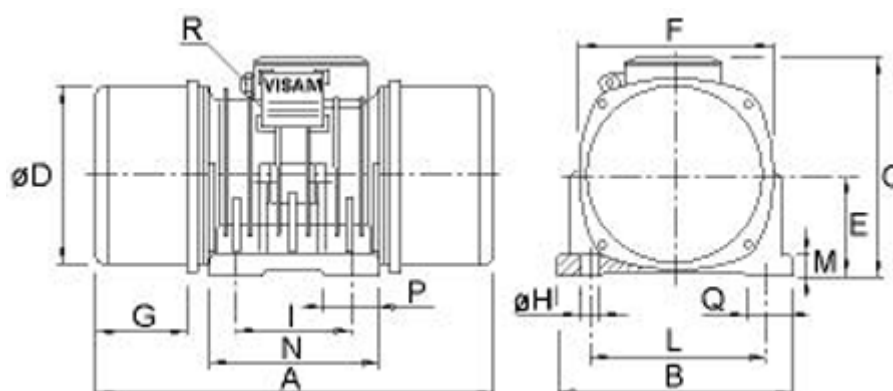

A = 252	L = 106
B = 152	M = 12
C = 143	N = 100
d = 92	Number H = 4
E = 62	P = 35
G = 50	Q = 40
H = 9	R = M16x1,5
I = 62-74	